

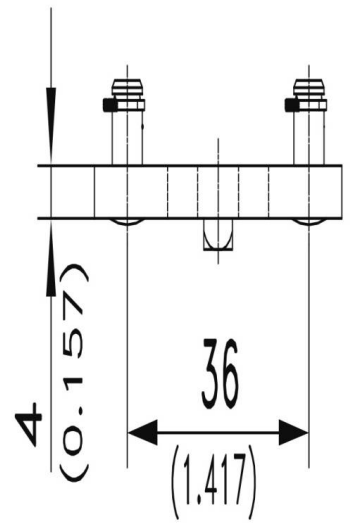

CAME H 42 3 POINTS

81-7-3542

Poids (g)	57 g
------------------	------

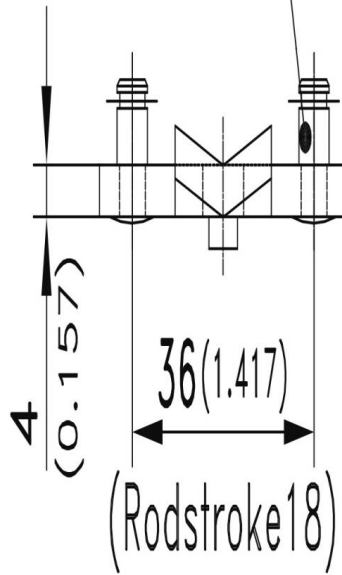
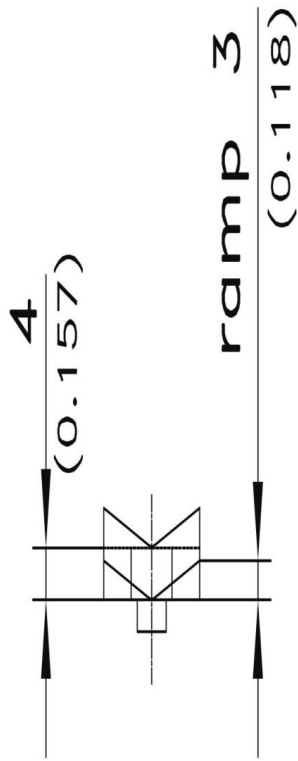
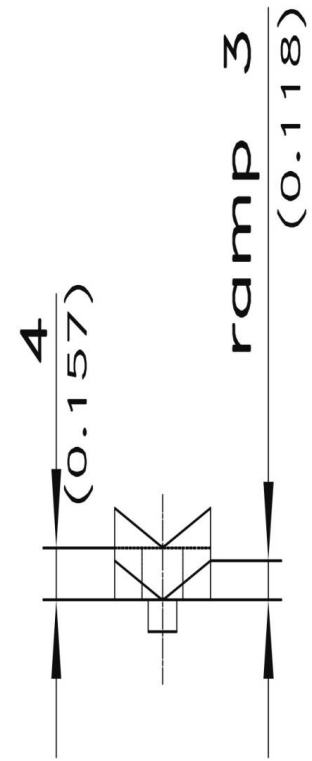

Stubs $\varnothing 6\text{mm}$ (0.236)
for c-clips RS 5
(are included)

