

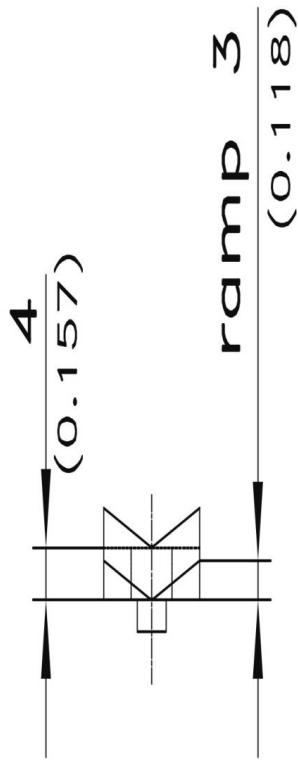

CAME H 30 3 POINTS

81-7-3530

Poids (g)	50 g
------------------	------

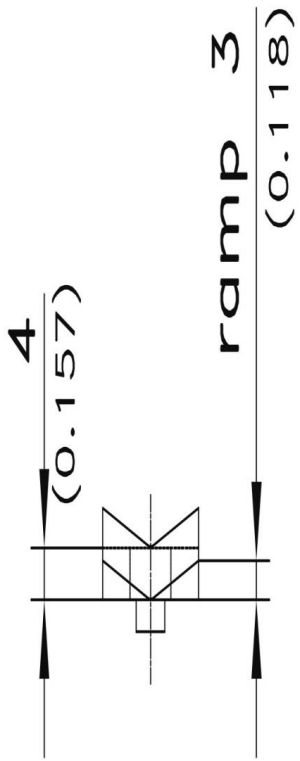
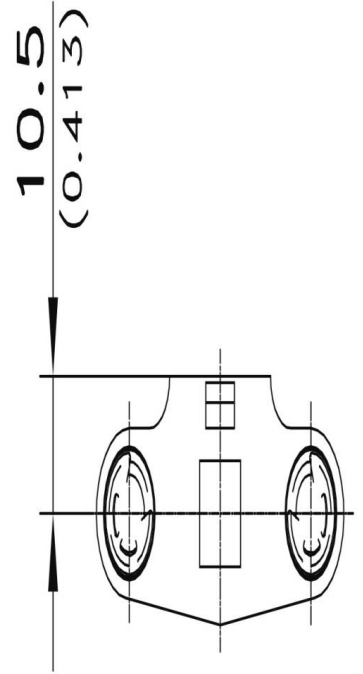
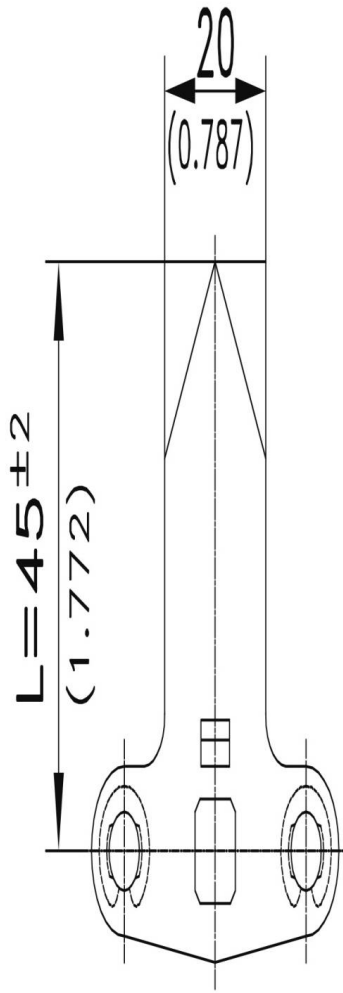
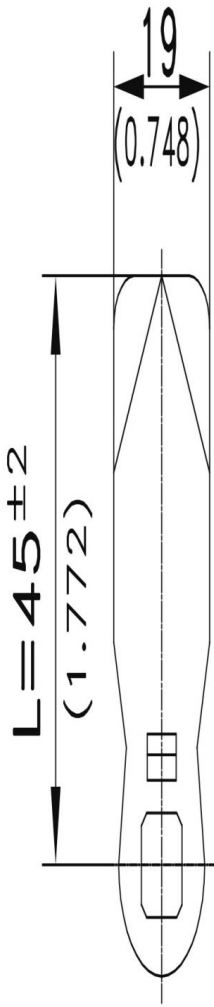
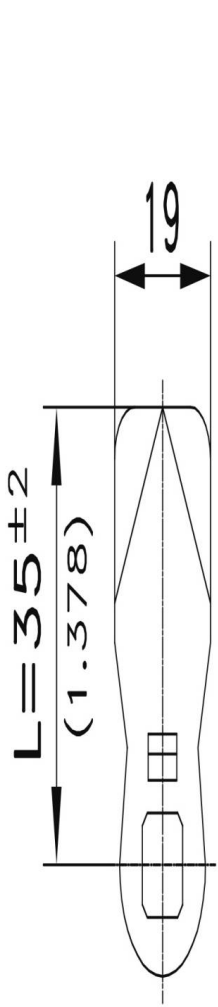

Stubs $\varnothing 6\text{mm}$ (0.236)
for c-clips RS 5
(are included)

