

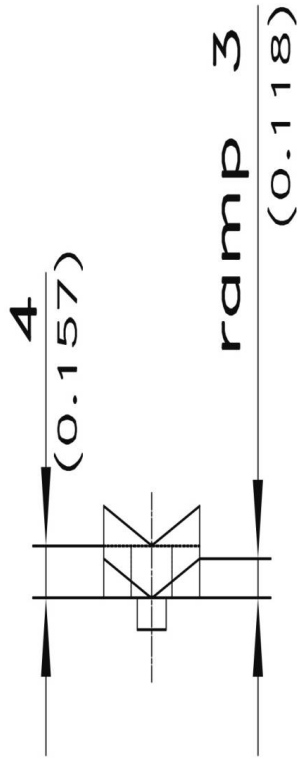

CAME H 28 3 POINTS

81-7-3528

Poids (g)	50 g
------------------	------

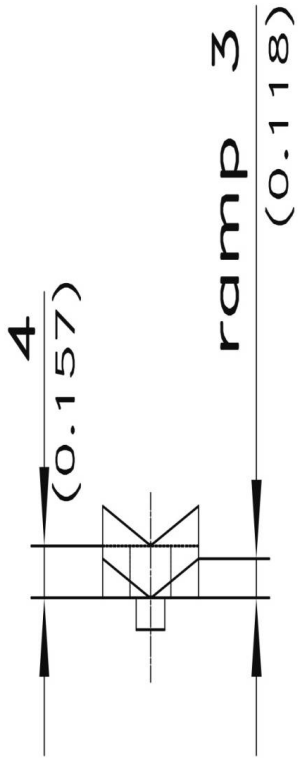
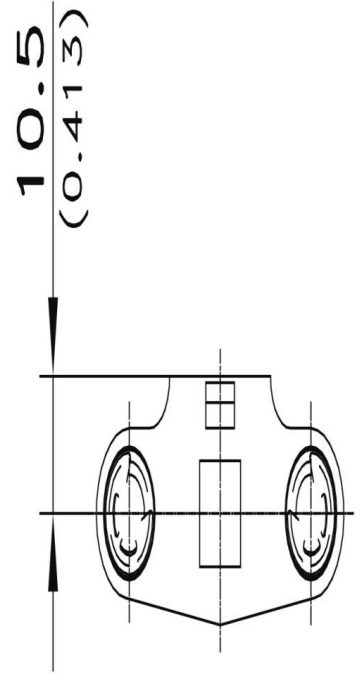
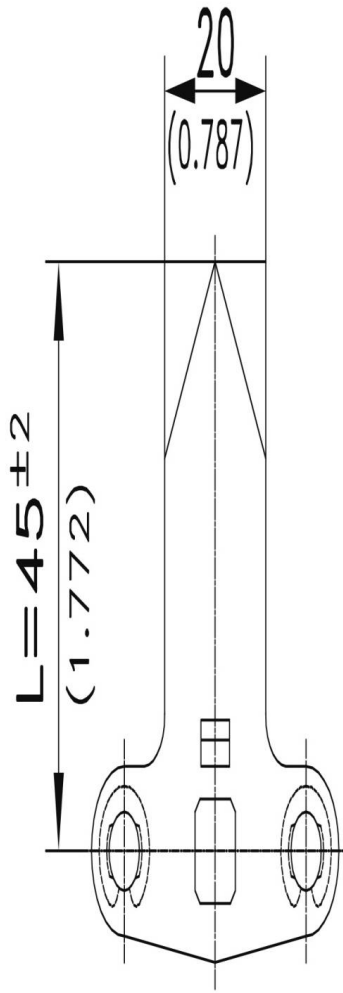
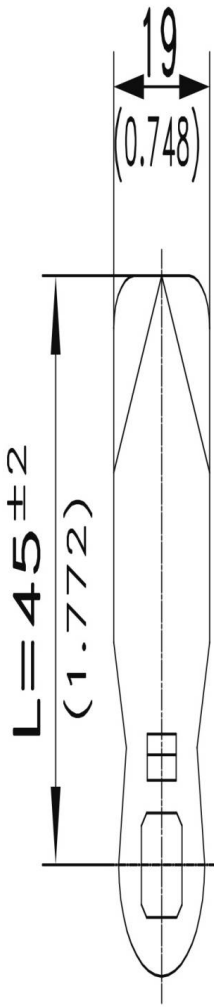
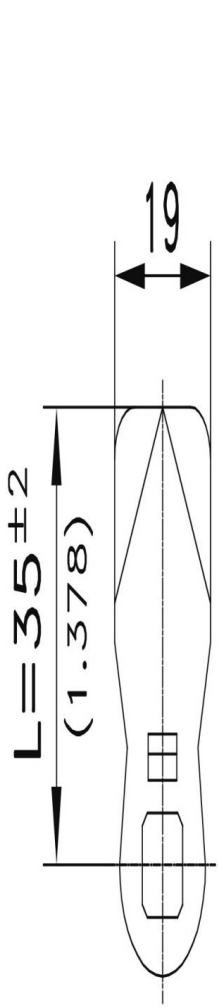

Stubs $\varnothing 6\text{mm}$ (0.236)
for c-clips RS 5
(are included)

