

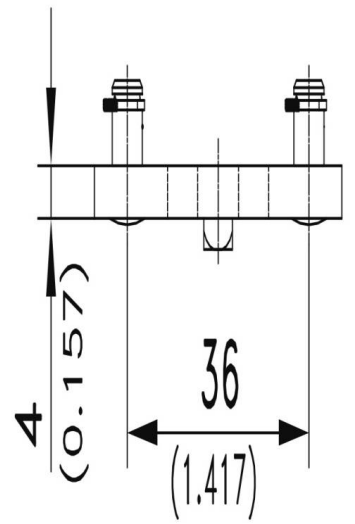

CAME H 22 3 POINTS

81-7-3522

Poids (g)	46 g
------------------	------

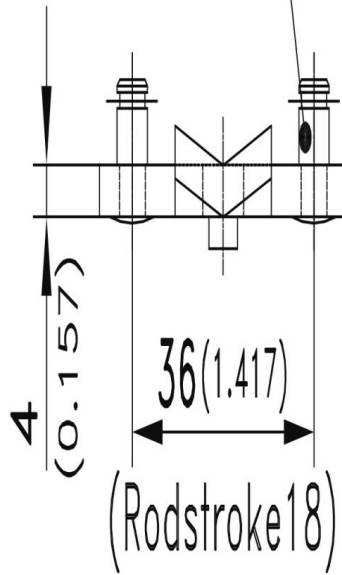
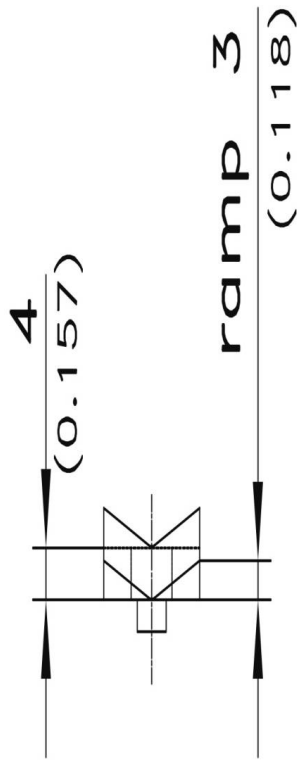
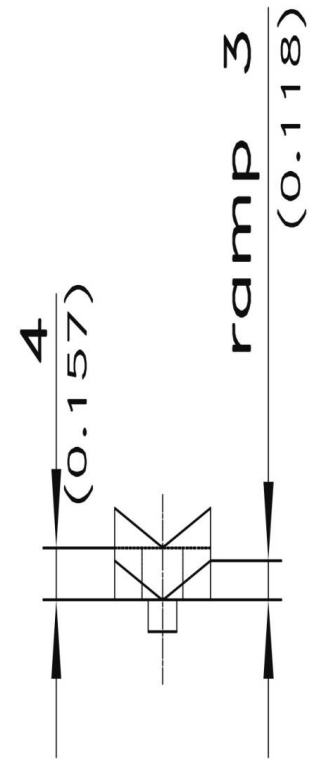

Stubs $\varnothing 6\text{mm}$ (0.236)
for c-clips RS 5
(are included)

