

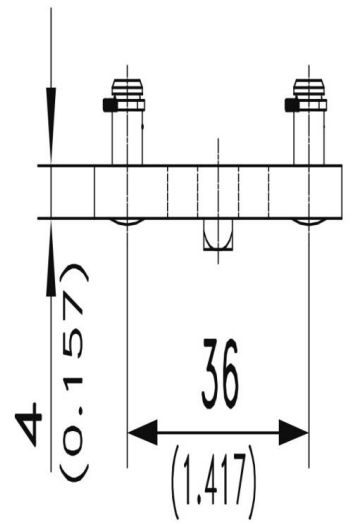

CAME H 10 3 POINTS

81-7-3510

Poids (g)	47 g
------------------	------

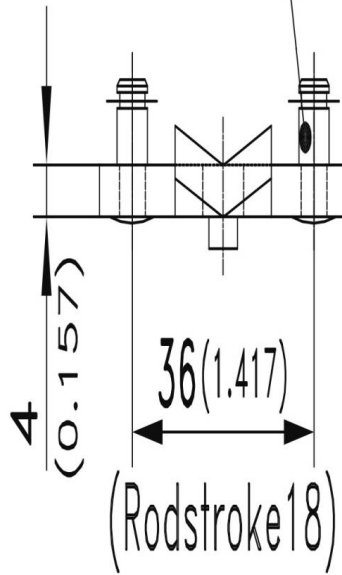
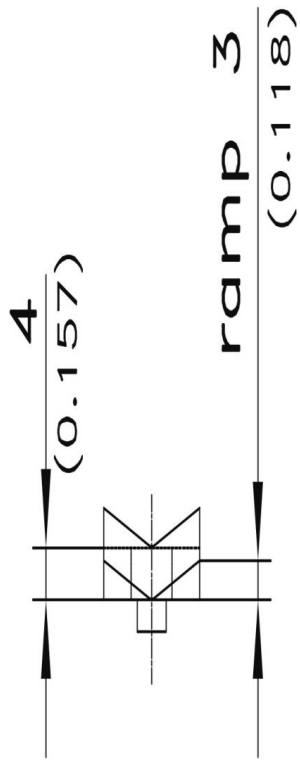
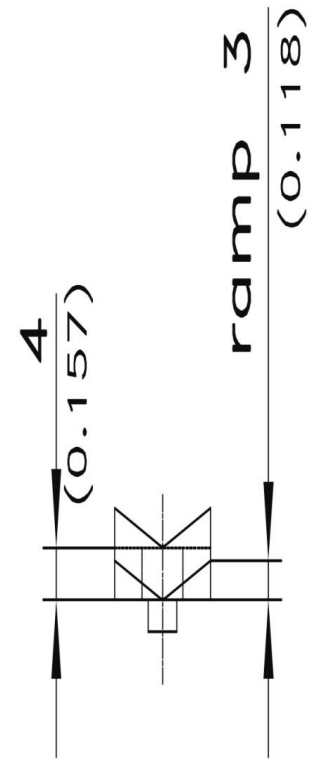

Stubs $\varnothing 6\text{mm}$ (0.236)
for c-clips RS 5
(are included)

