

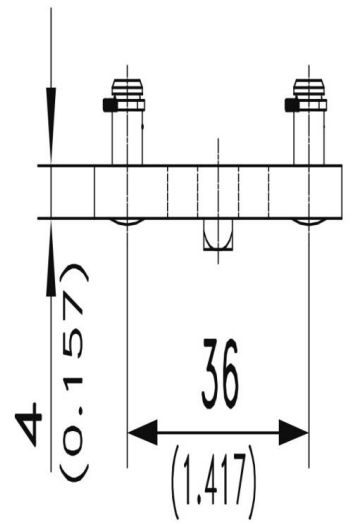

## **CAME 35**

**81-7-3235**

<b>Poids (g)</b>	28 g
------------------	------

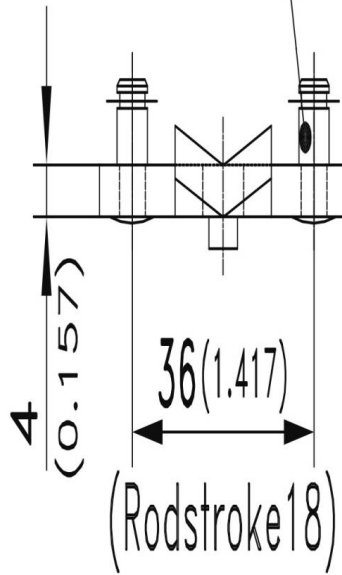
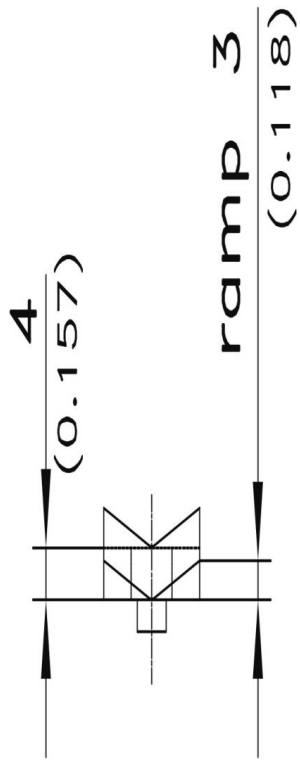
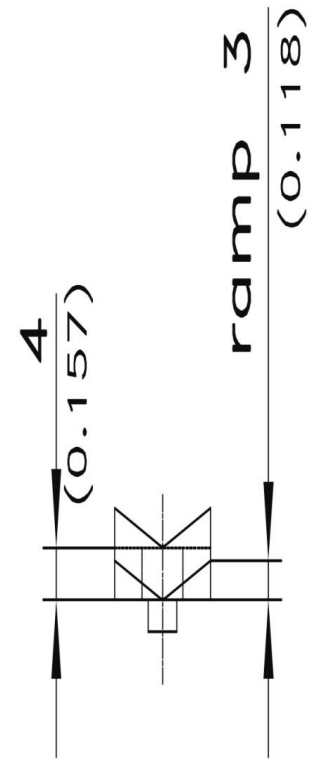

Stubs  $\varnothing 6\text{mm}$  (0.236)  
for c-clips RS 5  
(are included)

