

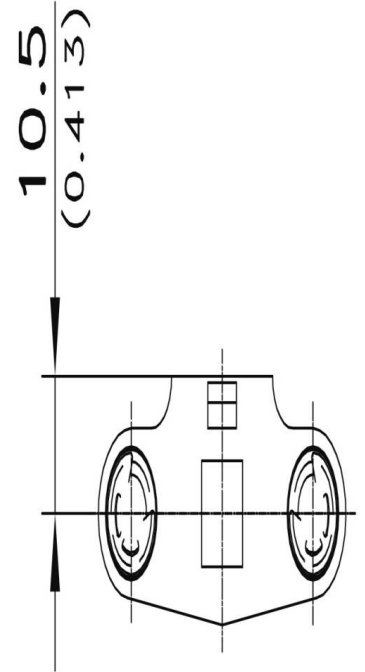

CAME 35

81-7-3213

Poids (g)	20 g
------------------	------

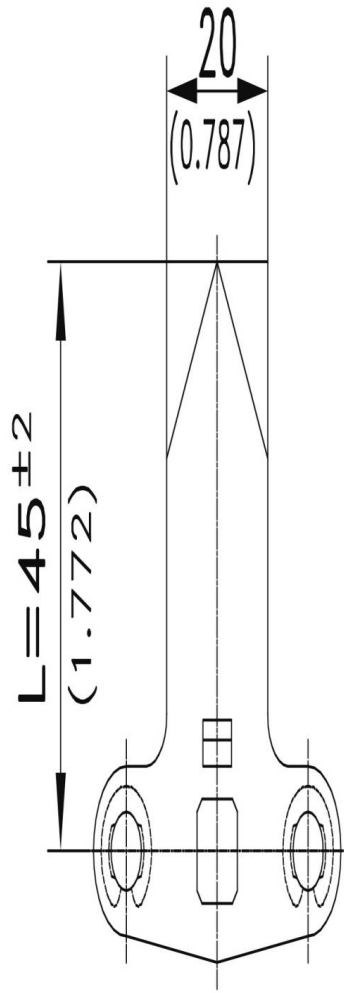
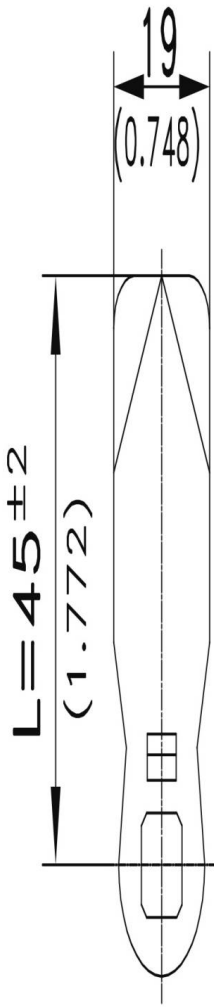
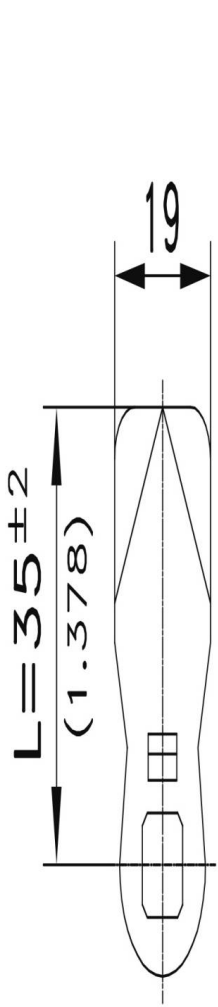
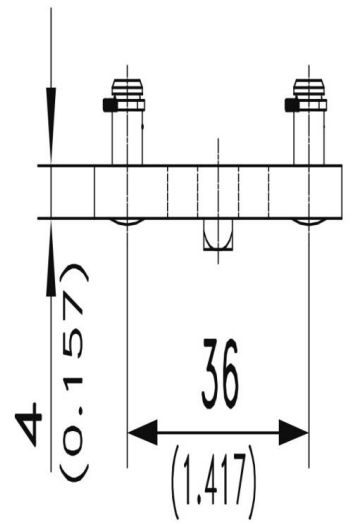
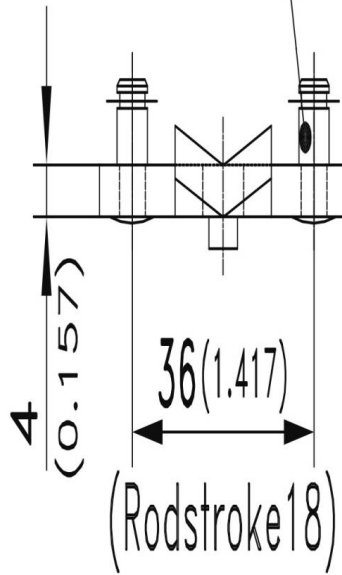
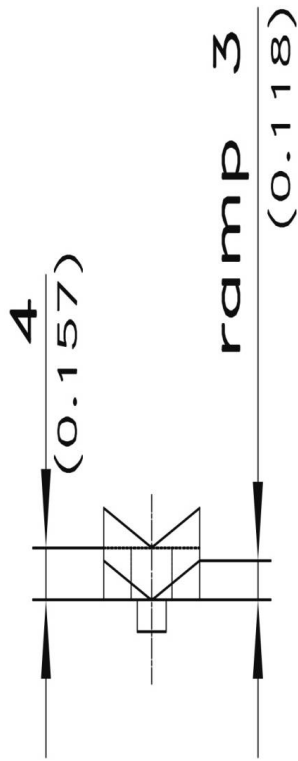
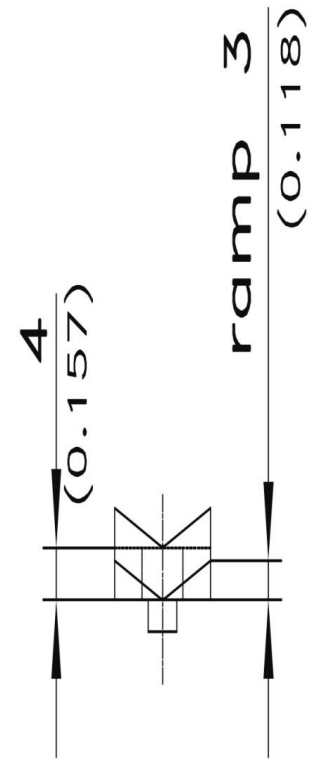

Stubs $\varnothing 6\text{mm}$ (0.236)
for c-clips RS 5
(are included)