



## **PAUMELLES EN ZAMAK 64 X 50 MM**

**72-1-9003**

Rondelle en nylon.  
Broche en acier.

<b>A</b>	64 mm
<b>Note</b>	type 1
<b>Matière</b>	zamak

<b>Poids (g)</b>	247 g
<b>B</b>	50 mm
<b>C</b>	17.5 mm
<b>Finition</b>	noir

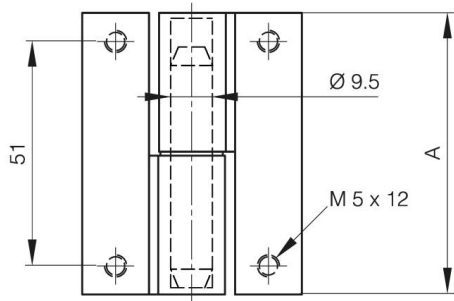

72-1-9003

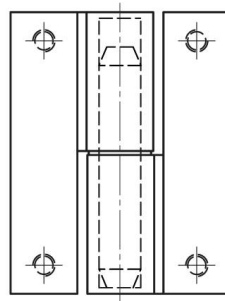

72-1-9002

