



PAUMELLES LONGUEUR 60 À 80 MM

14-7-3399

A	68 mm
Note	type 2
Matière	acier
Poids (g)	46 g

B	45 mm
C	1.5 mm
S (diamètre trou)	4.5 mm
E (Charnon ou épaisseur)	6 mm
D (diamètre broche ou fil)	4.5
F (entraxe)	8 mm
G (pas des trous)	54 mm
Finition	nickelé

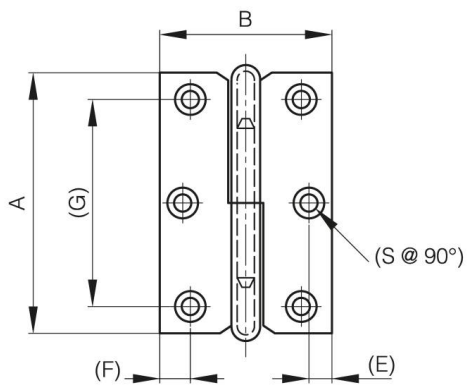

14-7-3396 & 14-7-3398 & 14-7-3400

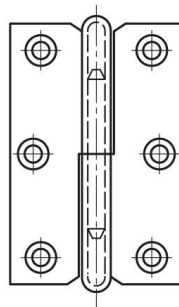

14-7-3397 & 14-7-3399 & 14-7-3401

