



## PAUMELLES EN PLASTIQUE

14-7-3723

Paumelles en polyamide chargé 15% fibre de verre, broche en inox 303.

<b>A</b>	74 mm
<b>Note</b>	type 2
<b>Matière</b>	polyamide

<b>Poids (g)</b>	53 g
<b>B</b>	60 mm
<b>C</b>	7 mm
<b>S (diamètre trou)</b>	5 mm
<b>D (diamètre broche ou fil)</b>	9.5
<b>Finition</b>	noir

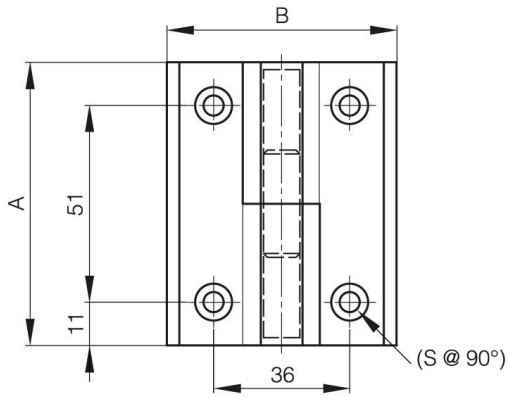

14-7-3722

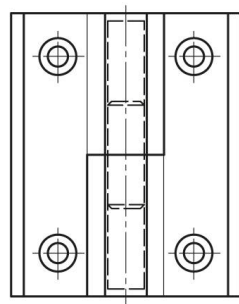

14-7-3723

