



ZINC DIE-CAST LIFT-OFF HINGES 64 X 33 MM

72-1-9001

Nylon washer.

A	64 mm
Note	type 1

Material	zinc die-cast
Weight (g)	144 g
B	33 mm
C	17.5 mm
Finish	black

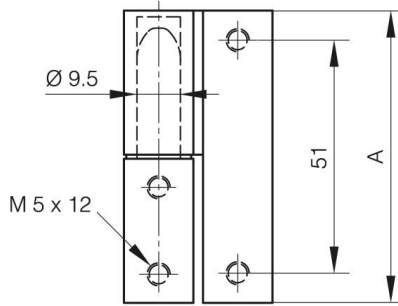

72-1-9001

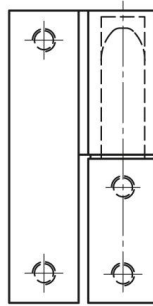

72-1-9000

