



LIFT-OFF HINGES 100 X 82 MM - STAINLESS STEEL WITH 8 HOLES

14-7-3679

Only the visible side has a brushed finish.

Produced mainly in stainless steel, for a complete description of the materials contact us.

A	100 mm
Note	type 2 / square corners

Material	304 stainless steel
Weight (g)	220 g
B	82 mm
C	2.5 mm
S (hole diameter)	6 mm
D (pin diameter)	7
Finish	brushed

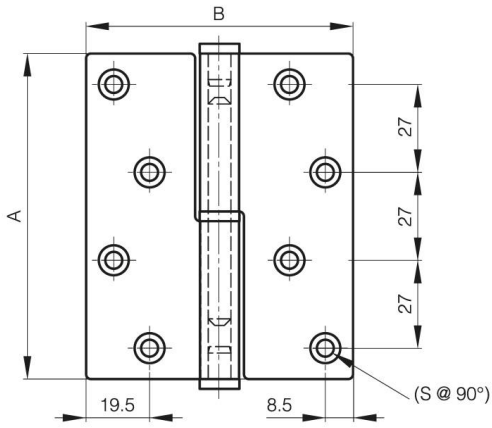

14-7-3675

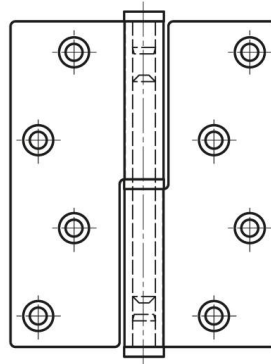

14-7-3679

