



FLAG HINGE WITHOUT WASHER - FLAT KNUCKLE

12-1-3310

A	80 mm
Note	type 1
Material	steel

Weight (g)	76 g
B	48 mm
C	2 mm
E (knuckle or thickness)	40 mm
D (pin diameter)	5.8
Finish	raw

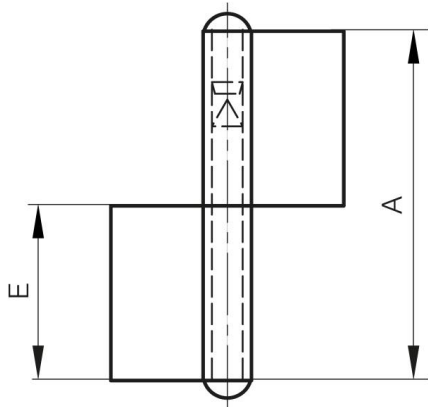

12-1-3308 & 12-1-3310

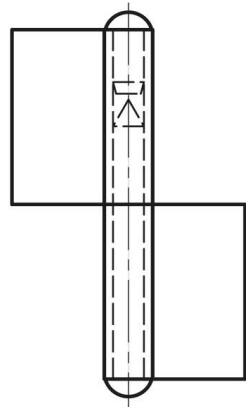

12-1-3307 & 12-1-3309

