



FLAG HINGE WITHOUT WASHER - FLAT KNUCKLE

12-1-3308

A	60 mm
Note	type 1
Material	steel

Weight (g)	39 g
B	40 mm
C	1.5 mm
E (knuckle or thickness)	30 mm
D (pin diameter)	5.3
Finish	raw

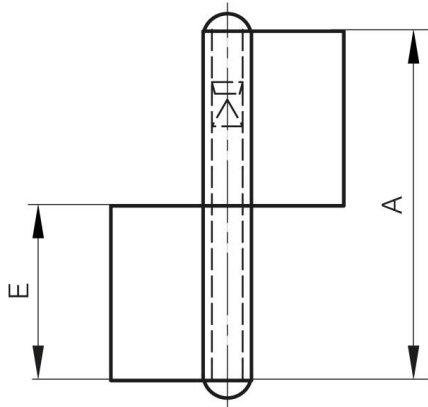

12-1-3308 & 12-1-3310

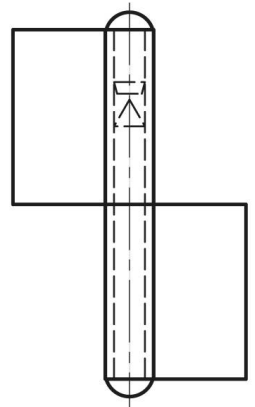

12-1-3307 & 12-1-3309

