



ALUMINIUM LIFT-OFF HINGES 80 X 80 MM

14-7-3625

Zinc plated steel pin.
Nylon bushing.

A	80 mm
Note	type 2
Material	aluminium

Weight (g)	85 g
B	80 mm
C	3.5 mm
S (hole diameter)	5.5 mm
D (pin diameter)	8
Finish	anodised silver

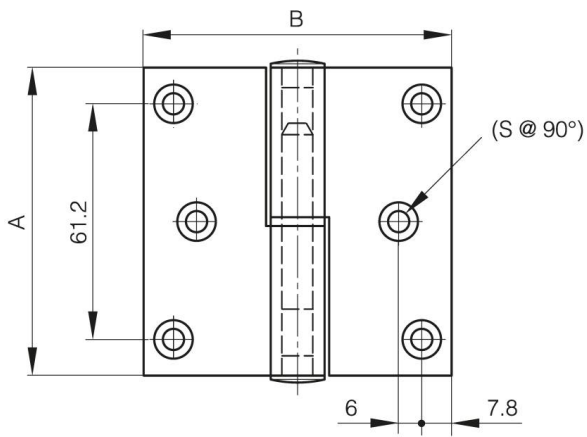

14-7-3624

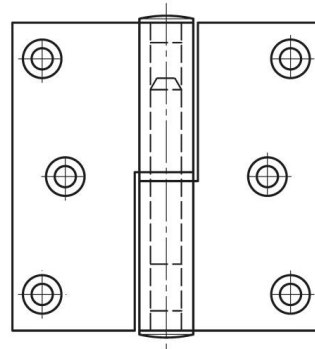

14-7-3625

