



## **FITSCHBÄNDER LÄNGE VON 60 BIS 80 MM**

**14-7-3399**

<b>A</b>	68 mm
<b>Ausführung</b>	Typ 2
<b>Material</b>	Stahl
<b>Gewicht (g)</b>	46 g

<b>B</b>	45 mm
<b>C</b>	1.5 mm
<b>S (Lochdurchmesser)</b>	4.5 mm
<b>E (Gelenkteile oder Dicke)</b>	6 mm
<b>D (Durchmesser)</b>	4.5
<b>F (Abstand)</b>	8 mm
<b>G (Abstand)</b>	54 mm
<b>Dekor</b>	vernickelt

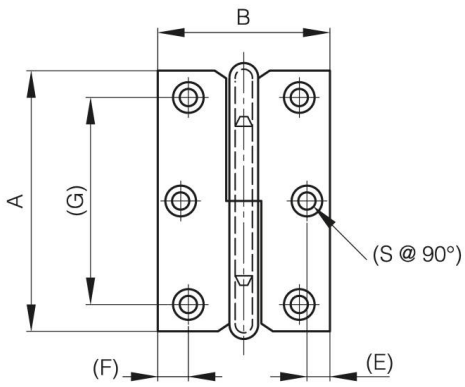

14-7-3396 & 14-7-3398 & 14-7-3400

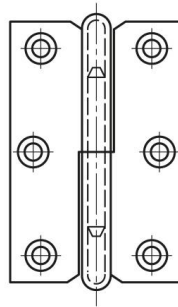

14-7-3397 & 14-7-3399 & 14-7-3401

